

SiM3L1xx BADGER BOARD USER'S GUIDE

1. Introduction

The Badger Board is controlled by Silicon Labs' SiM3L1xx, an ultra low-power Cortex-M3 microcontroller. The entire board is powered solely by a small supercapacitor and demonstrates best-in-class low-power operation. The board can remain running with the LCD enabled for days from as little as a 90-second charge and, under typical use, can last up to a week from a three to five minute charge. Figure 1 shows the SiM3L1xx Badger Board.

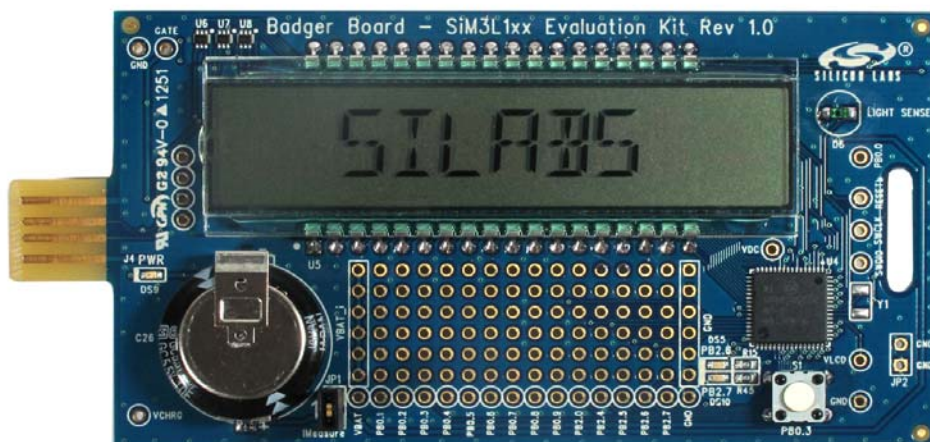

Figure 1. SiM3L1xx Badger Board

The SiM3L1xx MCU has the following key power specs:

- 175 μ A/MHz active mode operation
- 950 nA supply current with LCD and contrast control enabled
- Segment resetting achieves 40 percent reduction in LCD load current
- 300 nA supply current with RTC in Crystal Mode
- 180 nA supply current with RTC in LFO Mode
- 75 nA supply current in Power Mode 8

The Silicon Labs Precision32™ SiM3L1xx 32-bit MCUs are ideal candidates for ultra low-power system designs. In addition to providing an evaluation platform for ultra low-power LCD-based designs, the SiM3L1xx Badger Board serves as a lower-cost, general-purpose development platform for the SiM3L1xx MCUs.

2. Relevant Documents

This document provides a hardware and software overview for the SiM3L1xx Badger Board. Additional documentation on the Precision32 tools and MCUs can be found on the following Silicon Labs web sites:

www.silabs.com/32bit-appnotes

www.silabs.com/32bit-software

www.silabs.com/32bit-mcu

5. Charging the Badger Board

The badger board is charging any time it is plugged into USB and the blue LED (DS9) is turned on. The badger board will charge to 75% capacity (3.3 V) in approximately 90 seconds and to 100% capacity (3.8 V) in 3 to 5 minutes. There is no risk of overcharging the supercapacitor if the board is connected to USB indefinitely.

6. Demonstration Mode

The demonstration mode cycles through the key power specs for the SiM3L1xx MCU. Press the push button switch (S1) to advance to the next specification. After all the specifications have been displayed, the elapsed time (since the charger was last disconnected) and the current voltage on the super capacitor are displayed on the LCD.

After approximately one minute of inactivity, the badger board will return to the home screen displaying the letters "SILABS".

7. Badge Mode

Holding the push button switch (S1) for approximately three seconds and releasing it when four arrows appear in the top left corner of the LCD will toggle the badger board between demonstration mode and badge mode. In badge mode, a user-defined string of up to 40 characters is displayed on the LCD. Strings longer than eight characters will automatically scroll across the LCD display.

There are two ways to specify the user-defined string. The first method is to use Toolstick Terminal, and the second method is through the light sensor. The Toolstick Terminal creates a serial communication link between the PC and the MCU using the existing USB connection to carry data. The Terminal should be configured for 9600 baud 8-N-1 communication. Upon detecting a terminal connection, the badger board will automatically enter badge mode and display any string entered into the terminal. Figure 4 shows a screen capture of the Toolstick Terminal.

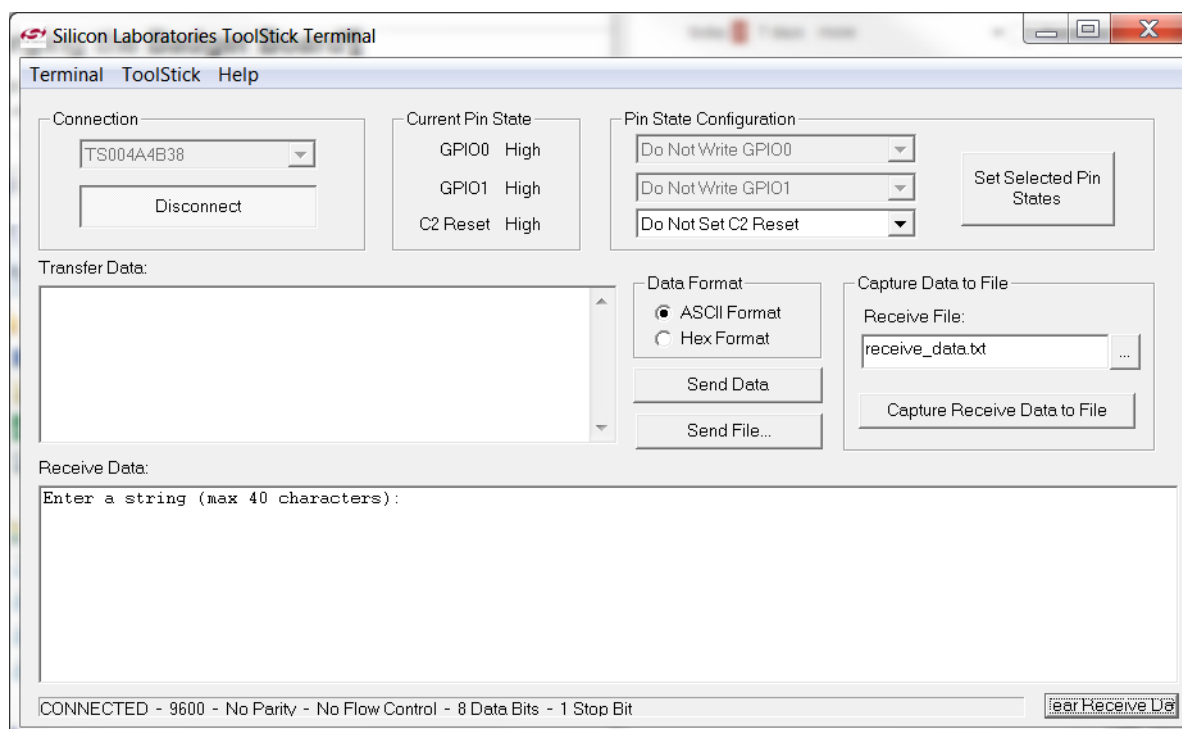

Figure 4. Toolstick Terminal

8. Programming Mode

The user-defined string can be programmed through the light sensor. Hold the push button switch (S1) down until four arrows appear and then disappear from the screen (approximately six seconds). Upon releasing the switch, the LCD will display "Sensing" and begin a 10-second countdown. A "light-to-dark" transition on the light sensor will initiate the data transfer over the light sensor.

The Badger Board iOS App, available from the iTunes App Store, can be used to generate the light pulses necessary to specify a user string. Type the string into the text box and press start to begin. The screen of the iOS device will turn dark and begin a countdown. Touching the screen will pause the countdown and provide additional time to place the iOS device near the light sensor. Placing the iOS device face down on the light sensor with the dark screen showing will generate the "light-to-dark" transition required to synchronize the devices.

Once the countdown on the iOS device expires, a series of light pulses will be generated by the iOS device and captured by the light sensor. After the transmission is complete, the user string is displayed on the badger board LCD. Figure 5 shows screenshots from the iOS application and a badger board user string being updated over the light sensor interface.

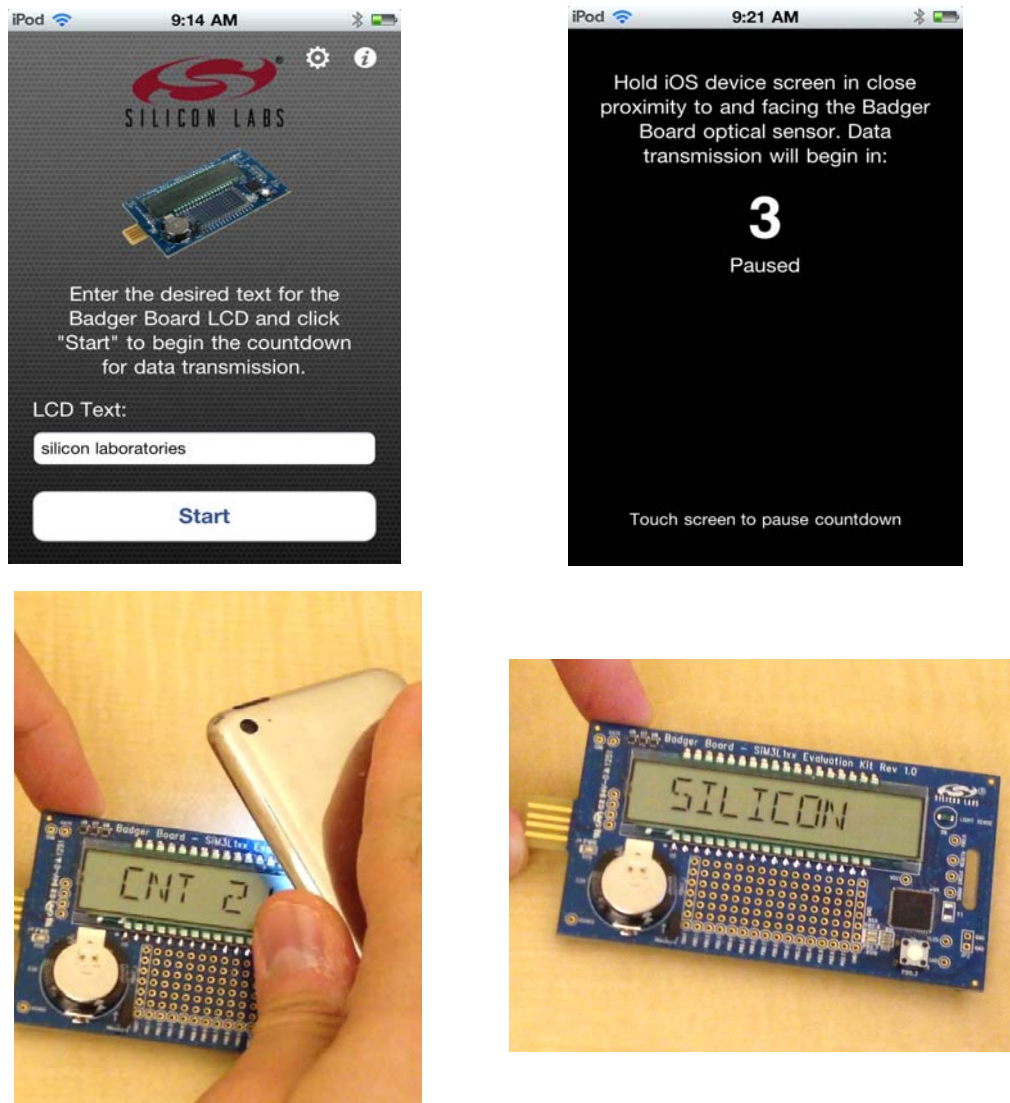

Figure 5. Updating User String over Light Sensor Interface

Occasionally, ambient light conditions will not be ideal for updating the user-defined string over the light sensor interface. It is important that the iOS device be located in close proximity to the badger board to block out ambient light when it is transmitting a “dark” pulse. It is equally important to ensure that the iOS screen brightness is set high enough to generate sufficient light when transmitting a “light” pulse. On iOS 5 and later devices, the screen brightness will automatically be set to maximum brightness during the transmission and then restored to the user setting. This feature can be disabled from the configuration menu.

The default transmission rate is 60 Hz (or 60 pulses per second). For operation under non-ideal conditions, the transmission rate may be slowed down to reduce the chance of experiencing bit errors. Figure 6 shows the configuration menu on an iOS 4 device.

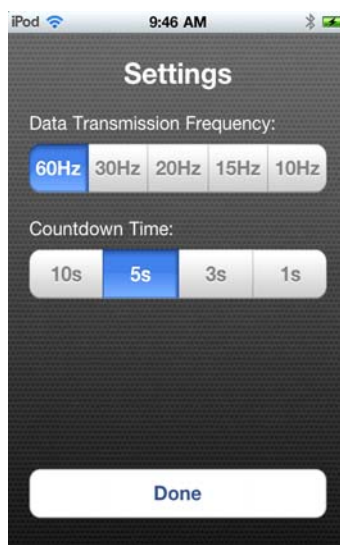

Figure 6. iOS 4 Device Configuration Menu

9. Turning Off the Badger Board

The badger board can be turned off by holding the push button switch (S1) until four arrows appear, disappear, and then a single down arrow appears (approximately eight seconds). When turned off, pressing the push button switch turns on the device.

10. Badger Board Hardware Overview

The badger board enables low-power application development on the SiM3L166 MCU and easy prototyping for other SiM3L1xx MCUs. Figure 7 shows the badger board features. Full schematics for the board can be found in 12. "Schematics" on page 9.

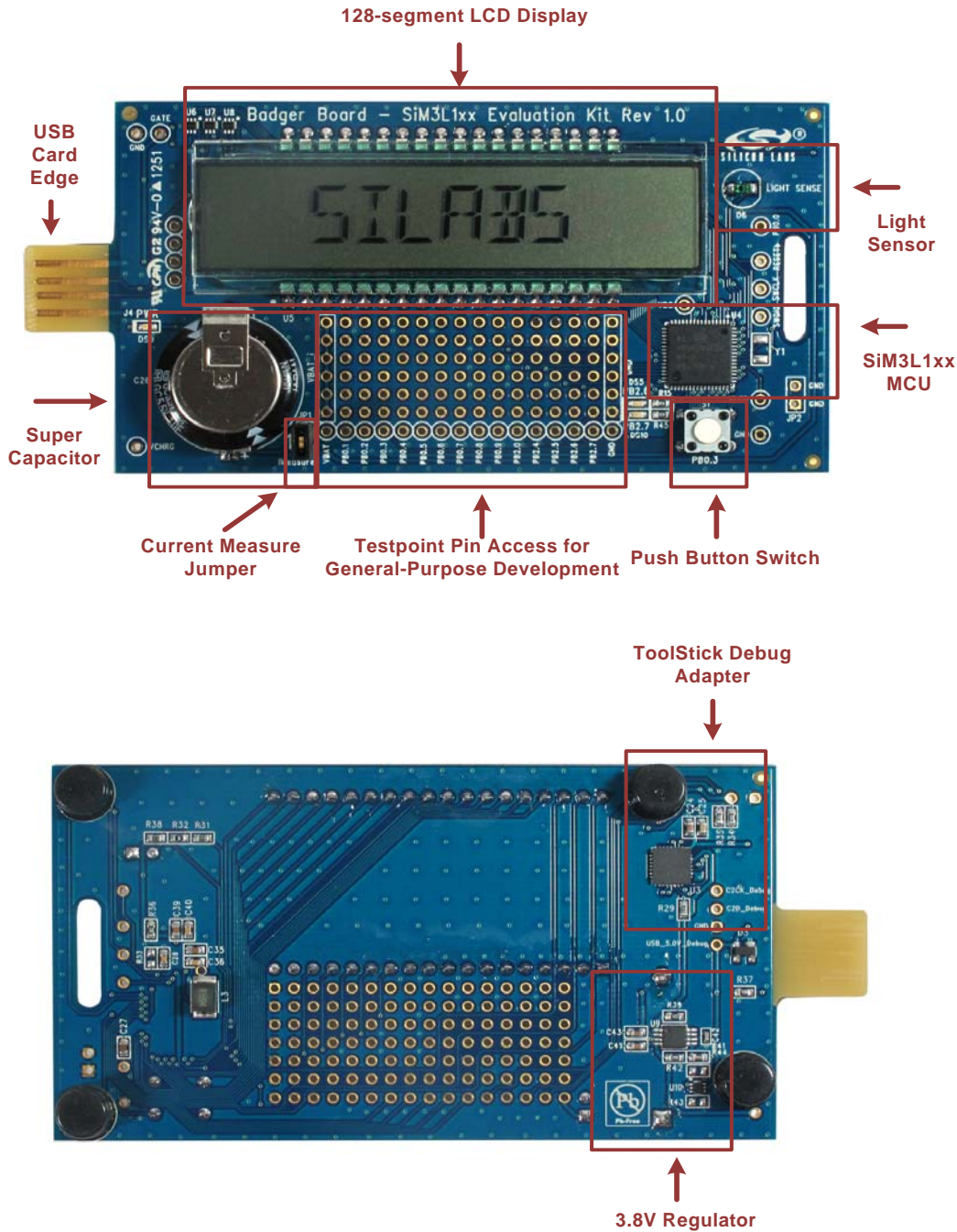

Figure 7. Badger Board Features

10.1. Push-Button Switches and LEDs (S1, DS5, DS9, DS10)

The badger board has a push-button switch and two LEDs summarized in Table 1. The switches connect to PB0.3 (S1). The switch is normally open and pulls the pin voltage to ground when pressed.

Port pin PB2.6 connects to the red LED (DS8), and PB2.7 connects to the green LED (DS10). The blue power LED (DS9) turns on when USB power is applied to the board. The red and green LEDs connect to VBAT through a current-limiting resistor and are enabled by driving the pin voltage to ground.

Table 1. Badger Board Switch and LEDs

GPIO Pin	Switch or LED
PB0.3	Push-Button Switch (S1)
PB2.6	Red LED (DS5)
PB2.7	Green LED (DS10)
—	Blue POWER LED (DS9)

10.2. Super Capacitor (C26) and Current Measurement Header(JP1)

The supercapacitor (C26) is the energy storage medium used in the badger board. Removing the shorting block from JP1 will disconnect the supercapacitor from the MCU and allow the MCU's supply current to be measured. When plugged into USB, the supercapacitor is charged to a nominal voltage of 3.8 V.

10.3. ToolStick Debug Adapter (U3)

The badger board features a debug adapter via the card edge USB connector. This debug adapter can be used with the Precision32 (1.0.2 and higher) and ARM uVision IDEs (4.54 and higher). When using an older version of the IDEs, the debug adapter DLLs in the IDE directories must be replaced to support the ToolStick Debug Adapter. Contact technical support (see "Contact Information" on page 14) for more information.

The ToolStick Debug Adapter also provides a ToolStick Terminal interface, which creates a virtual USB-based terminal to access the UART pins on the MCU. Connecting the board to an older version of the ARM uVision IDE or using an older version of the Flash Programming Utility may result in the Debug Adapter firmware being downgraded and loss of the ToolStick Terminal interface. If this occurs, simply perform a firmware update as described in 4. "Firmware Update" on page 2, and this process will restore the ToolStick Terminal interface.

11. Badger Board Firmware Overview

11.1. System Overview

The badger board firmware uses an event-driven architecture to stay in Power Mode 8 (PM8) at all times except when necessary to perform a system task. The two hardware wakeup sources used are pin wake and RTC wake. In active mode, the MCU operates on its 20 MHz low-power oscillator, and the APB clock is set to AHB/2.

11.2. SiM3L166 Module Usage

The modules used by the badger board firmware are:

- **SARADC0**: Measures the supercapacitor voltage
- **LPTIMER0**: Performs auto-baud detection when communicating over the light sensor interface
- **USART0**: Used for updating the user string using ToolStick Terminal
- **RTC0 in LFO mode**: Provides a time base for software and sets the LCD refresh rate
- **LCD0**: Drives the LCD

11.3. Power Saving Software Techniques

The badger board firmware implements a number of power saving techniques to allow the badger board to achieve a long operating life:

- **Event Driven Architecture**: Firmware architecture maximizes time spent in the ultra-low-power PM8.
- **Segment Resetting**: LCD segment resetting reduces load current by up to 40%.
- **Vector-Based Scrolling**: Strings longer than eight characters are turned into a series of vectors stored in RAM, which can be very efficiently loaded into the LCD registers. Using this method significantly reduces the CPU time required to repaint the LCD.
- **Display Auto-Off**: Software will automatically turn off the display after 15 minutes when the supercapacitor voltage is below 2.5 V. Pressing the push-button switch turns on the display.

11.4. Firmware Listing

The badger board firmware is distributed with this application note.

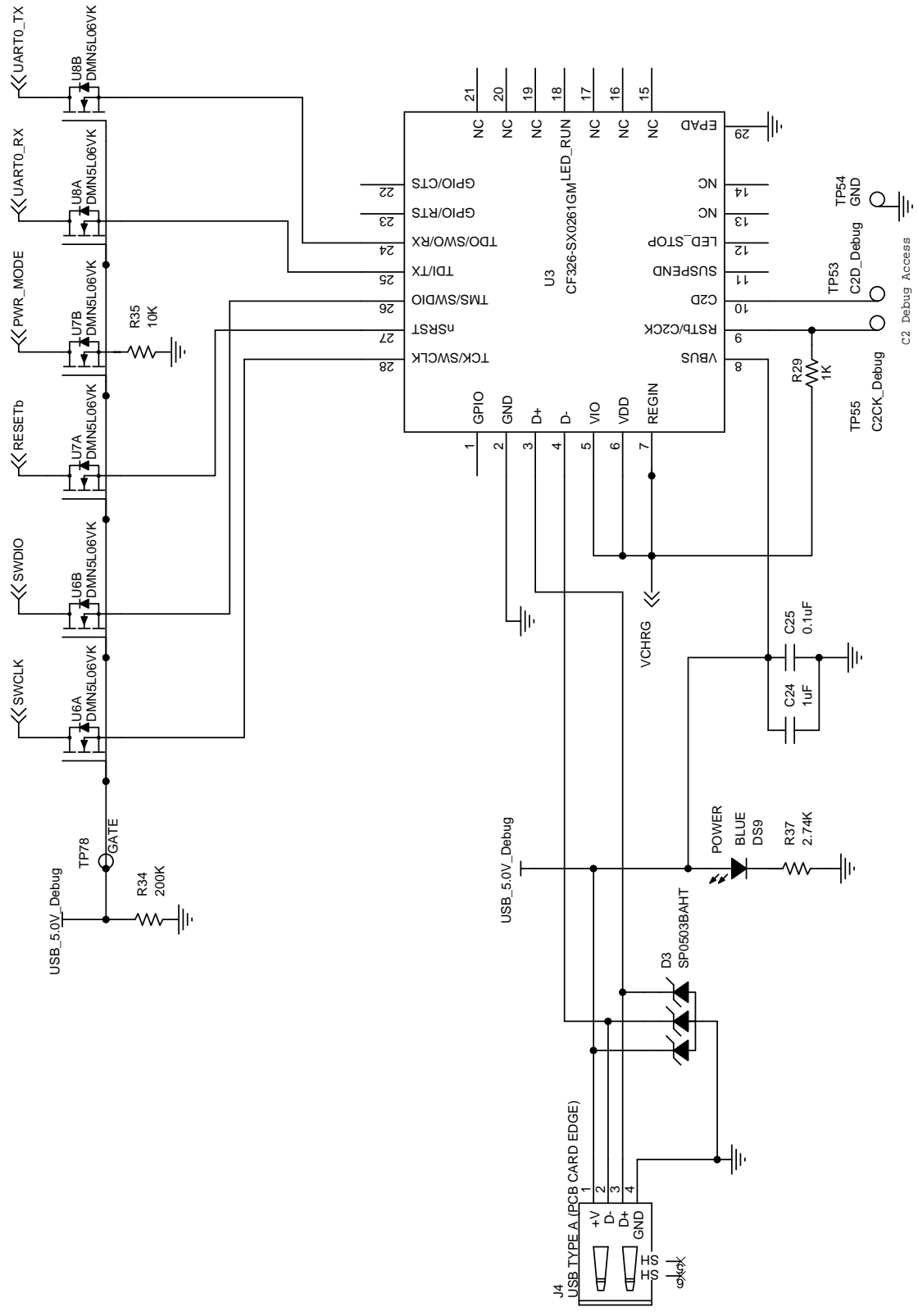

Figure 9. Badger Board Schematic (2 of 3)

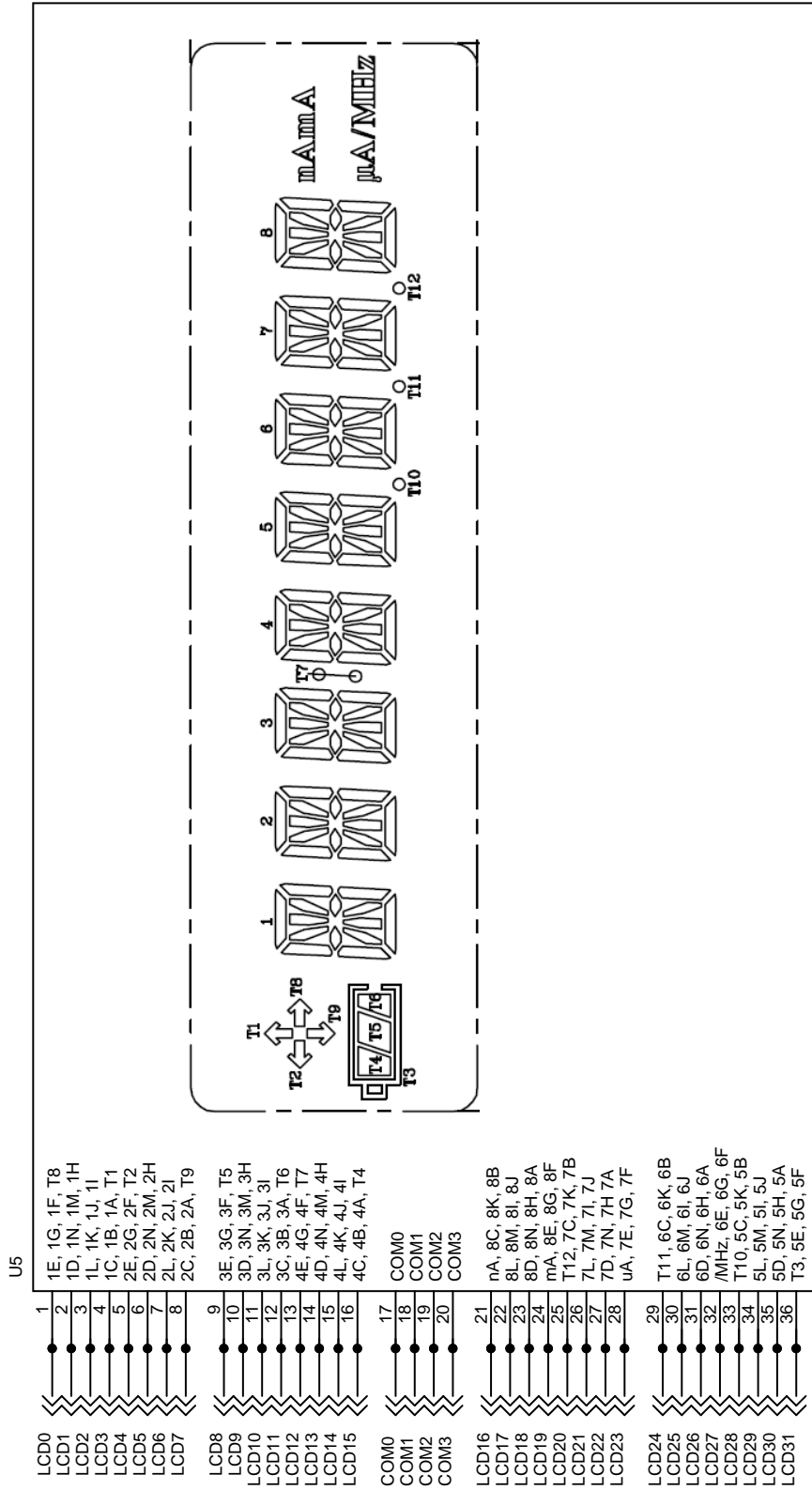

Figure 10. Badger Board Schematic (3 of 3)

13. Bill of Materials

Table 2. Badger Board Bill of Materials

Reference	Part Number	Source	Description
C24, C39	C0603X7R100-105K	Venkel	1 μ F Capacitor
C25, C28, C36, C40	C0603X7R100-104K	Venkel	0.1 μ F Capacitor
C26	EEC-S5R5H105	Panasonic	1F Super Capacitor
C27	C0603X5R6R3-106M	Venkel	10 μ F Capacitor
C35, C41, C43	C0603X7R100-225K	Venkel	2.2 μ F Capacitor
C42	C0402X7R160-333K	Venkel	33 nF Capacitor
D3	SP0503BAHTG	Littlefuse	SP0503BAHT Protection Diode
D6	TEMT6200FX01	Vishay	570 nm Light Sensor
DS10	SML-LX0603GW	Lumex Inc.	Green LED
DS5	SML-LX0603IW	Lumex Inc.	Red LED
DS9	LTST-C190TBKT	Lite-On Technology Corp	Blue LED
J4	USB A PLUG	NONE	USB Type A (PCB Card Edge)
JP1	TSW-102-07-T-S	Samtec	Header
JS1, JS2	SNT-100-BK-T	Samtec	Jumper Shunt
L3	ELJ-FBR56MF	Panasonic	560 nH Inductor
R15, R45	CR0603-16W-7500F	Venkel	750 Ω Resistor
R29	CR0603-10W-1001F	Venkel	1 k Ω Resistor
R32	CR0603-16W-000	Venkel	0 Ω Resistor
R31, R38			470 k Ω Resistor
R34	CR0603-10W-2003F	Venkel	200 k Ω Resistor
R35	CR0603-10W-103J	Venkel	10 k Ω Resistor
R36	CR0603-10W-1001J	Venkel	1 k Ω Resistor
R37	CR0603-16W-2741F	Venkel	2.74 k Ω Resistor
R39	CR0603-10W-104J	Venkel	100 k Ω Resistor
R41	CR0603-10W-1213F	Venkel	121 k Ω Resistor
R42	ERJ-3EKF2493V	Panasonic	249 k Ω Resistor

Table 2. Badger Board Bill of Materials (Continued)

Reference	Part Number	Source	Description
S1	EVQ-PAD04M	Panasonic Corp.	Momentary
SF1, SF2, SF3, SF4	SJ61A6	3M	Bumper
U3	CF326-SX0261GM	SiLabs	CF326-SX0261GM
U4	SiM3L166-C-GM	SiLabs	SiM3L166-C-GM
U5	GS-12811BA-1-1	Glory Sound Asia	LCD 14x8 Current Measure Icons
U6, U7, U8, U10	DMN5L06VK	Diodes Inc.	DMN5L06VK
U9	LP3982IMM-ADJ	Texas Instruments	LP3982-ADJ

CONTACT INFORMATION

Silicon Laboratories Inc.

400 West Cesar Chavez
Austin, TX 78701
Tel: 1+(512) 416-8500
Fax: 1+(512) 416-9669
Toll Free: 1+(877) 444-3032

Please visit the Silicon Labs Technical Support web page:
<https://www.silabs.com/support/pages/contacttechnicalsupport.aspx>
and register to submit a technical support request.

Patent Notice

Silicon Labs invests in research and development to help our customers differentiate in the market with innovative low-power, small size, analog-intensive mixed-signal solutions. Silicon Labs' extensive patent portfolio is a testament to our unique approach and world-class engineering team.

The information in this document is believed to be accurate in all respects at the time of publication but is subject to change without notice. Silicon Laboratories assumes no responsibility for errors and omissions, and disclaims responsibility for any consequences resulting from the use of information included herein. Additionally, Silicon Laboratories assumes no responsibility for the functioning of undescribed features or parameters. Silicon Laboratories reserves the right to make changes without further notice. Silicon Laboratories makes no warranty, representation or guarantee regarding the suitability of its products for any particular purpose, nor does Silicon Laboratories assume any liability arising out of the application or use of any product or circuit, and specifically disclaims any and all liability, including without limitation consequential or incidental damages. Silicon Laboratories products are not designed, intended, or authorized for use in applications intended to support or sustain life, or for any other application in which the failure of the Silicon Laboratories product could create a situation where personal injury or death may occur. Should Buyer purchase or use Silicon Laboratories products for any such unintended or unauthorized application, Buyer shall indemnify and hold Silicon Laboratories harmless against all claims and damages.

Silicon Laboratories and Silicon Labs are trademarks of Silicon Laboratories Inc.
Other products or brandnames mentioned herein are trademarks or registered trademarks of their respective holders.